



ST 010 102 6705



- with WAVES structure
- 160mm projection
- fixed spout
- rectangular spray pattern with 40 individual jets
- height of mixer 204 mm
- height up to aerator 190 mm
- hole diameter valve 32 mm
- hole diameter spout 35 mm
- rosette 60 x 47 mm
- 2x screw-in M 10 x 1 pressure hose, leak-tested
- max. flow 4 l/min
- lead-free
- This product can help a building meet the requirements of Green Building Rating Systems, e.g. LEED®, BREEAM®, DGNB

	Brushed Platinum	ST 010 102 6705-06
	Chrome	ST 010 102 6705-00
	Brushed Dark Platinum	ST 010 102 6705-99

Individual components of this set







You need the following components for this set

	1x	13 715 705-06		1x	20 005 705-06
	1x	20 005 706-06			

ST 010 102 6705



- 160mm projection
- fixed spout
- rectangular spray pattern with 40 individual jets
- height of mixer 204 mm
- height up to aerator 190 mm
- hole diameter 35 mm
- 2x screw-in M 10 x 1 pressure hose, leak-tested
- 1/2" connection
- max. flow 4 l/min
- lead-free
- This product can help a building meet the requirements of Green Building Rating Systems, e.g. LEED®, BREEAM®, DGNB

	Brushed Platinum	13 715 705-06
	Chrome	13 715 705-00
	Dark Chrome	13 715 705-19
	Brushed Champagne (22kt Gold)	13 715 705-46
	Champagne (22kt Gold)	13 715 705-47
	Brushed Dark Platinum	13 715 705-99

ST 010 102 6705

mm [inches]

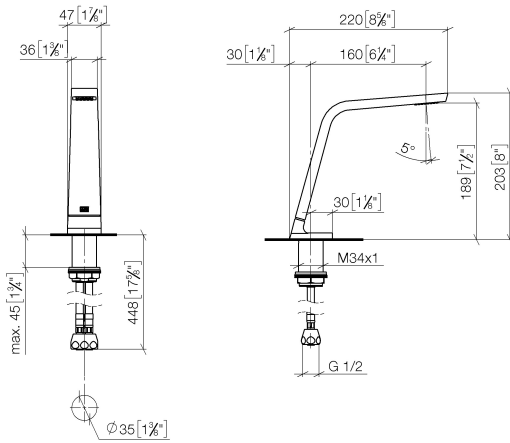

Flow rate chart



Certificates

GDV_0400279. LGA_28686. IAPMO_N-4976. IAPMO_8834 (1). IAPMO_4976 (6).

WRAS_1512011. IAPMO_6397.

ST 010 102 6705

Parts for other finishes can be found here: [Chrome](#)

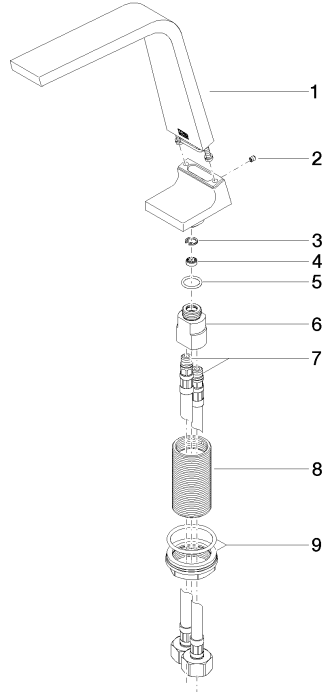







Spare parts list

No.	Item Number	Name	Quantity used	Delivery time
1	90 11 70 003 00-06	spout	1	10
2	09 31 11 044 90	pin	1	2
3	09 16 01 016 90	ring	1	2
4	09 23 01 034 90	flow reducer	1	2
5	09 14 10 130 90	seal	1	2
6	09 11 10 055 10 90	connection	1	2
7	04 30 04 019 00 90	hose	2	2
8	09 30 01 208 90	connection	1	2
9	04 23 10 044 06 90	fixing set	1	2

ST 010 102 6705

- with WAVES structure
- hole diameter 32 mm
- rosette 60 x 47 mm
- with cold marking



	Brushed Platinum	20 005 705-06
	Chrome	20 005 705-00
	Dark Chrome	20 005 705-19
	Brushed Champagne (22kt Gold)	20 005 705-46
	Champagne (22kt Gold)	20 005 705-47
	Brushed Dark Platinum	20 005 705-99



CL.1 Three-hole basin mixer without pop-up waste - Brushed Platinum

CL.1

ST 010 102 6705

ST 010 102 6705

mm [inches]

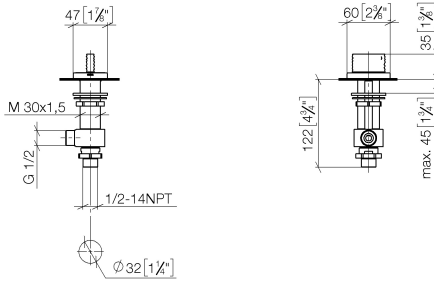

Flow rate chart

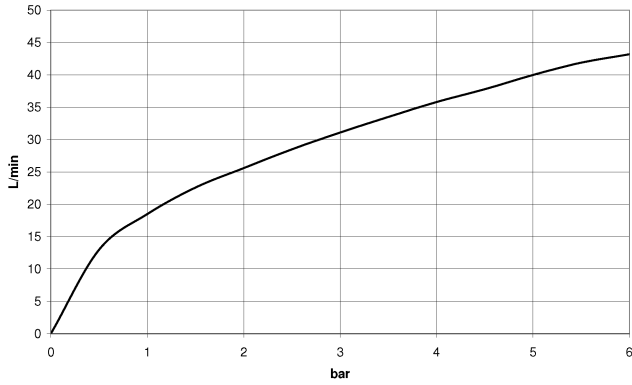

Certificates

WRAS_1804020. IAPMO_4976 (5). IAPMO_N-4976. LGA_28687. IAPMO_6397.

WRAS_240202020.

ST 010 102 6705

Parts for other finishes can be found here: [Chrome](#)

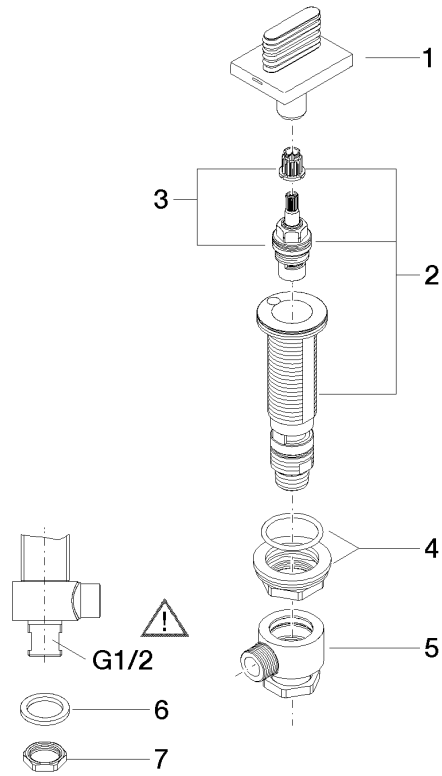







Spare parts list

No.	Item Number	Name	Quantity used	Delivery time
1	90 20 70 055 06-06	handle (cold)	1	10
2	04 17 11 058 53 90	side panel	1	2
3	90 90 03 153 00 90	top	1	2
4	04 23 10 032 78 90	fixing set	1	2
5	04 17 11 023 10 90	distributor	1	2
6	90 23 30 040 00-06	threaded connector	1	10
7	09 30 11 059 90	disc	1	2
8	09 23 10 012 90	nut	1	2

ST 010 102 6705

- with WAVES structure
- hole diameter 32 mm
- rosette 60 x 47 mm
- with hot marking



	Brushed Platinum	20 005 706-06
	Chrome	20 005 706-00
	Dark Chrome	20 005 706-19
	Brushed Champagne (22kt Gold)	20 005 706-46
	Champagne (22kt Gold)	20 005 706-47
	Brushed Dark Platinum	20 005 706-99



CL.1 Three-hole basin mixer without pop-up waste - Brushed Platinum

CL.1

ST 010 102 6705

ST 010 102 6705

mm [inches]

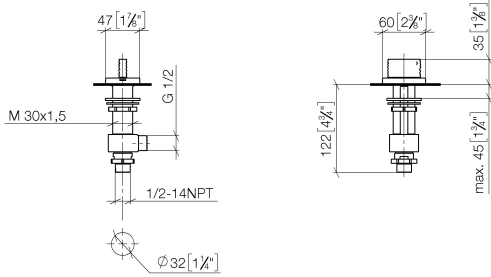

Flow rate chart



Certificates

WRAS_1804020. IAPMO_4976 (5). IAPMO_N-4976. LGA_28687. IAPMO_6397.

WRAS_240202020.

ST 010 102 6705

Parts for other finishes can be found here: [Chrome](#)

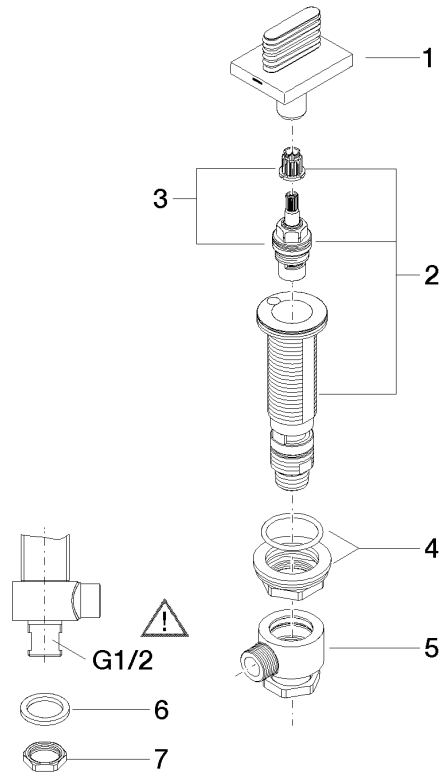

Spare parts list

No.	Item Number	Name	Quantity used	Delivery time
1	90 20 70 055 07-06	handle (hot)	1	10
2	04 17 11 058 52 90	side panel	1	2
3	90 90 03 152 00 90	top	1	2
4	04 23 10 032 78 90	fixing set	1	2
5	04 17 11 023 10 90	distributor	1	2
6	90 23 30 040 00-06	threaded connector	1	10
7	09 30 11 059 90	disc	1	2
8	09 23 10 012 90	nut	1	2